

DU144 Automatic Bypass Valve

Installation instructions

Building Regulations

An Automatic Bypass Valve (DU144) controls water flow in the Heating Circuit according to the water pressure across it and is used to maintain a minimum flow rate through the boiler and to limit circulation pressure when other water paths are closed.

A bypass circuit must be installed if the Boiler manufacturer requires one, or specifies that a minimum flow rate has to be maintained whilst the Boiler is firing.

The use of Automatic Bypass Valves becomes particularly important when Heating Systems include large numbers of Thermostatic Radiator Valves (TRVs) – whilst the TRVs are open the Automatic Bypass Valve remains closed, however, as the TRVs start to close, the Automatic Bypass Valve starts to open maintaining the required water flow through the boiler. Using an Automatic Bypass Valve is also likely to reduce noise in systems caused by excess water velocities.

Because manual or fixed position valves do not regulate the flow and allow water to bypass even when it is not necessary, Building Regulations require bypass circuits to use Automatic Bypass Valves and not fixed position valves.

Location in System

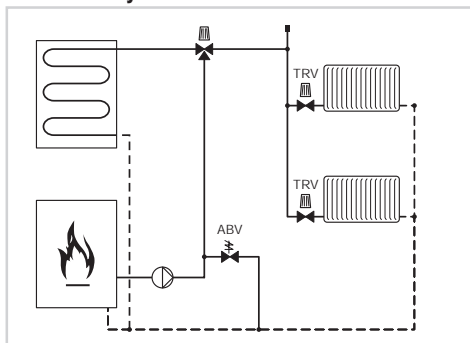

System with stored hot water

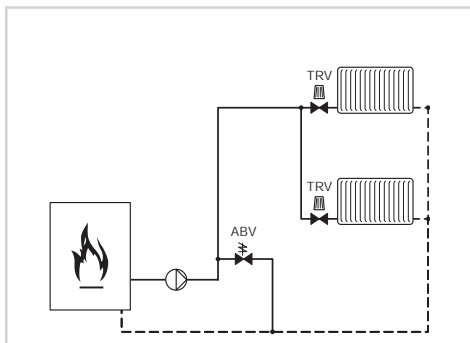

System with combi boiler

Installation

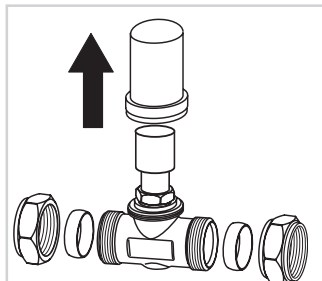

Remove protective cap to set

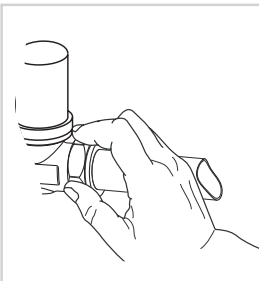

Install the DU144 with flow in the direction of the Arrow on the Body

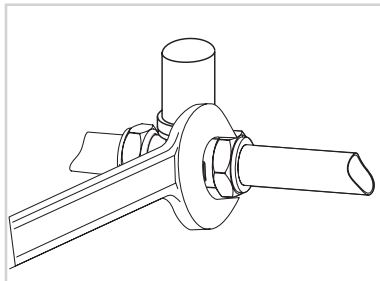

Use a correctly sized open ended spanner to tighten. Do not over tighten.

Setting Procedure

- 1) Commission and balance the Heating System – take note of the selected pump speed.
- 2) Using the Boiler manufacturer's instructions, find the minimum flow requirement for the Boiler.
- 3) Using the Pump manufacturer's Pump curves determine the available Pump head when operating at the required minimum flow and the selected Pump speed.
- 4) Using the DU144 Setting chart, the calculated Pump Head and the minimum Boiler Flow to find the optimum setting for the DU144

Note: To set the DU144, remove the protective cap and turn the setting handle until the bottom of the handle crosses the corresponding line on the DU144 stem.

Note: The cap is internally fixed with sealing wax during assembly. Turn firmly to break the seal.

Should persistent water velocity noise occur in the Heating System, gradually turn the DU144 to a lower setting until the noise is eliminated.

Important: replace protective cap after setting the DU144 to avoid tampering

Example :-

Minimum flow 300 l/h - Pump speed 3.
Pump chart indicates 4 m head (Use Pump Manufactures chart).

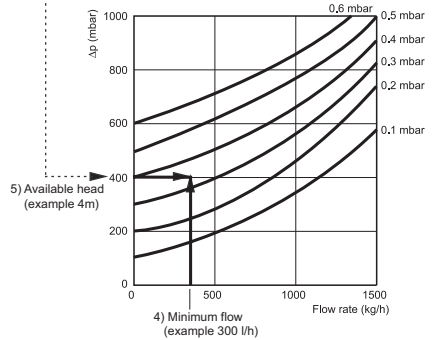
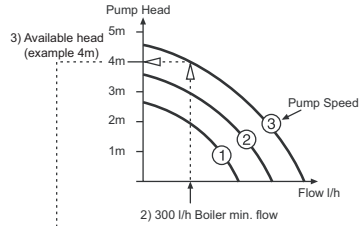

Using DU144 Setting Chart:

4m Head / Minimum Flow 300 l/h
Result = Set DU144 to setting 0.35

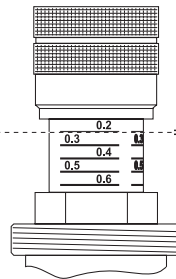
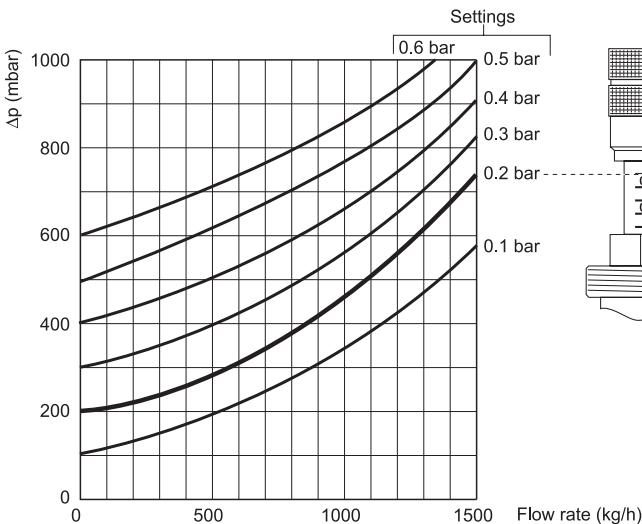

Note: For pre-setting use line below the number

Honeywell Control Systems Ltd.
Honeywell House
Arlington Business Park
Bracknell, Berkshire RG12 1EB
Phone: 01344 656000
Fax: 01344 656240

Honeywell