

Drayton

Digistat+ & Digistat+RF

Room Thermostat

Models:

30002 / RF601



Invensys Controls Europe
Technical Helpline: +44 (0) 845 130 7722
www.draytoncontrols.co.uk
Installation / User Guide 06490056001 (09/05)



What is a room thermostat?

... An explanation for householders

A room thermostat simply switches the heating system on and off as necessary. It works by sensing the air temperature, switching on the heating when the air temperature falls below the thermostat setting, and switching it off once this set temperature has been reached.

Turning a room thermostat to a higher setting will not make the room heat up any faster. How quickly the room heats up depends on the design of the heating system, for example, the size of boiler and radiators.

Neither does the setting affect how quickly the room cools down. Turning a room thermostat to a lower setting will result in the room being controlled at a lower temperature, and saves energy.

The heating system will not work if a time switch or programmer has switched it off.

The way to set and use your room thermostat is to find the lowest temperature setting that you are comfortable with, and then leave it alone to do its job. The best way to do this is to set the room thermostat to a low temperature – say 18°C – and then turn it up by one degree each day until you are comfortable with the temperature. You won't have to adjust the thermostat further. Any adjustment above this setting will waste energy and cost you more money.

If your heating system is a boiler with radiators, there will usually be only one room thermostat to control the whole house. But you can have different temperatures in individual rooms by installing thermostatic radiator valves (TRVs) on individual radiators. If you don't have TRVs, you should choose a temperature that is reasonable for the whole house. If you do have TRVs, you can choose a slightly higher setting to make sure that even the coldest room is comfortable, then prevent any overheating in other rooms by adjusting the TRVs.

Room thermostats need a free flow of air to sense the temperature, so they must not be covered by curtains or blocked by furniture. Nearby electric fires, televisions, wall or table lamps may prevent the thermostat from working properly.

User Guide

Your new thermostat with digital display.

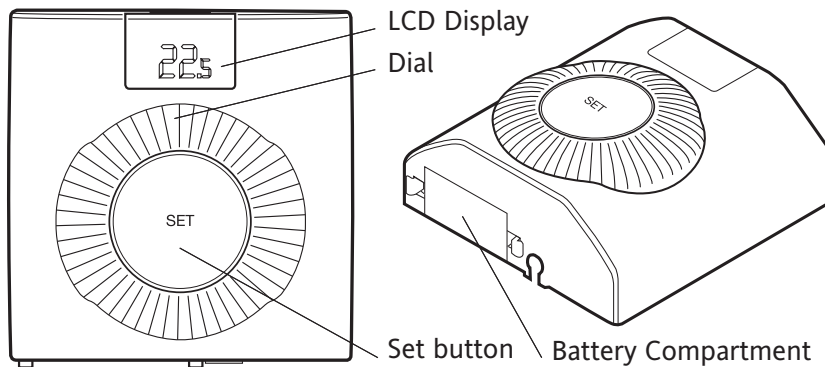

Thermostat Display – Features & Characters

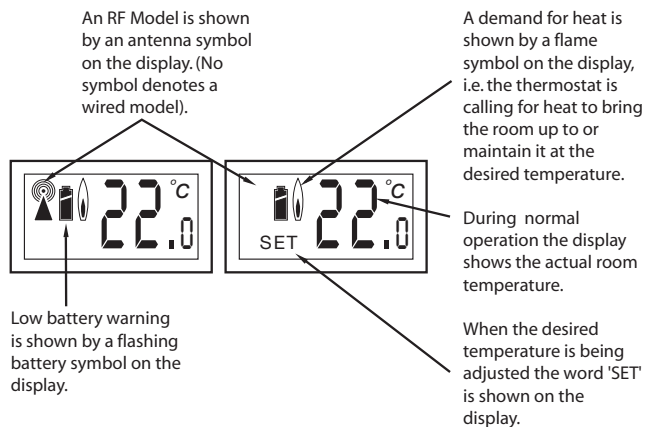

FEATURES

This product has the following user adjustable settings

- Required room temperature (temperature setpoint)
- Preset temperature setting - Advanced feature
- Minimum & Maximum temperature settings - Advanced feature

Simple Setting or Operating

To set the required room temperature

- The display normally shows the current room temperature to within 0.5°C
- To adjust the required temperature, turn the dial clockwise to increase or anti-clockwise to decrease, (1 click = 1°C), the LCD will display the temperature setpoint as it is being adjusted and 'SET' will be displayed. After a few seconds the display will return to normal operation and will display the actual room temperature.

While adjusting the temperature during normal operation, when you reach the maximum or minimum possible setting the display will flash to indicate you cannot adjust the product further.

ADVANCED FEATURES

Adjusting the Setpoint using the Preset Temperature Mode

Change the temperature at the press of a button, for example, if you are going out to the shops for an hour you can reduce the temperature to save energy and then when you press the button again on your return the setpoint will return to the previous level.

- To adjust the setpoint to the preset (or Setback) temperature, press the 'Set' button during normal operation and the product will go into Preset mode.

NB. This feature can be used to quickly adjust the temperature setpoint to a setback temperature for economy operation if for example, 'Preset Temperature = 15°C'. Or alternatively to a comfort setpoint if 'Preset Temperature = 21°C'.

- Once the setpoint has been changed to the preset (or setback) temperature by pressing 'Set' the display will show the 'Preset Temperature' and 'SET' will be flashing in the display as shown,

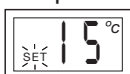

'SET' will flash for approximately 5 seconds and during this time the 'Preset Temperature' can be altered by rotating the dial.

- The product will remain in the Preset mode. Once 5 seconds have elapsed (since the last dial adjustment) the word 'SET' will stop flashing on the display as shown,



The product is still in the Preset mode.

You can either,

1. If you want to return to your previous setpoint (before you entered the Preset mode) then press the 'SET' button. The Preset mode will be cancelled and the product will return to normal operation and the display will show the current room temperature as shown,

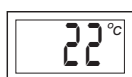

2. If you want to set a new setpoint, just rotate the dial until your required setpoint is shown on the display. After a couple of seconds the display will change to show the current room temperature as shown,

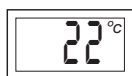

To change the user adjustable settings

- To enter the 'User' menu, press and hold the 'Set' button for more than 5 but less than 10 seconds – the display will show 'Pr' (Preset temperature setting) as shown,

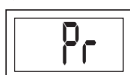

- If the dial is turned clockwise one click then 'Hi' (Maximum temperature setting) will be displayed and if turned one more click clockwise then 'Lo' (Minimum temperature setting) will be displayed.

Changing the Preset Temperature

- To adjust the 'Preset' temperature enter the user menu as described above, then rotate the dial until 'Pr' is shown, press the set button and the display will show the current Preset setting.

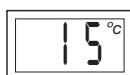

- Rotate the dial clockwise to increase the Preset temperature & anti-clockwise to reduce the Preset temperature. Press the 'Set' button to confirm and 'Pr' will be displayed.



Changing the Maximum Temperature Setting

- To adjust the maximum temperature setting enter the user menu as described above, then rotate the dial clockwise until 'HI' is showing.

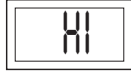

- Then press the 'Set' button, the current setting is shown.



- Rotate the dial clockwise to increase the maximum temperature setting (max.30°C) and anti-clockwise to reduce the maximum temperature setting (min 5°C or min. temp. setting). Press the 'Set' button to confirm, the display will show,



Changing the Minimum Temperature Setting

- To adjust the minimum temperature setting enter the user menu as described above, then rotate the dial clockwise until 'Lo' is showing.



- Then press the 'Set' button, the current setting is shown.

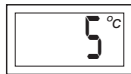

- Rotate the dial clockwise to increase the minimum temperature setting (max.30°C or max. temp. setting) and anti-clockwise to reduce the minimum temperature setting (min 5°C). Press the 'Set' button to confirm, the display will show,



While adjusting the settings within the menu, when you reach the maximum or minimum possible setting the display will flash to indicate you cannot adjust the product further, e.g. you cannot set the Preset higher than the maximum temperature setting.

To return to normal operation, either press the 'Set' button for more than 5sec or wait for 1 minute and it will return automatically.

TAMPER PROOFING (All Models)

To tamper proof the product i.e. prevent unauthorised adjustment of the product set the Min and Max temperatures to the same desired value.

FAULT DIAGNOSIS (All Models)

If the display shows E1, the following faults could have occurred

1. Internal temperature sensor has failed.
2. Ambient temperature is outside product operating temperature range.

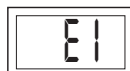

BATTERY REPLACEMENT (All Models)

- When the batteries are getting low (approx 30 days battery life remaining) the battery symbol will flash in the display, it is recommended to change the batteries during this period.
- After approx 30 days, a continuous battery symbol only will be shown in the display and the unit will remain OFF.



How to replace the batteries

Remove battery compartment

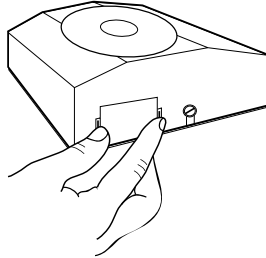

Remove the battery compartment by pinching the tabs and withdrawing downwards. Replace the spent batteries with 2 x AA 1.5V alkaline batteries ensuring correct orientation. Replace the battery compartment pressing fully home.

RF PRODUCT ONLY

SCR RECEIVER (RF Model only)

SCR (Receiver) Normal Operating Mode

- Once the 'Wireless System' has been commissioned, there should be little need for any user interaction with the SCR.
- During normal operation the red and green LEDs will occasionally be on, these signify the following;

Green LED

The green LED will be on when there is a demand for heating, and off when there is no demand.

Red LED

The red LED will flash for 7 seconds, approximately every 5 minutes. This denotes that a radio signal is being received from the Digistat+RF unit.

Situations Requiring Attention

Red LED continually flashing

- This denotes that the batteries in the Digistat+RF unit are approaching the end of their life (see 'battery replacement').

Red LED continually on

- This denotes that the SCR has been unable to receive a radio signal from the Digistat+RF unit. This may be caused by the batteries being dead (see 'battery replacement') or some temporary interference with the radio signal.
- To resend and test the signal, go to the Digistat+RF unit and open the battery drawer, after a few seconds (the display will go blank) close the battery drawer and then reset to your desired temperature. If the radio signal has been successfully transmitted and received, the red LED will flash for 7 seconds then go off.
- If the red LED stays on, there may be some other fault that will require the attention of a heating engineer/electrician.

Manual Override

- The heating can be manually switched on and off by using the 'OVERRIDE' button on the SCR in a fault situation, even though the red LED will stay on until a satisfactory signal is reinstated.
- Once the SCR receives a satisfactory signal again, it will automatically reset itself for normal operation.